

A71C-F

FLOW OPTIMIZED AXIAL FAN



► Specification

Number of Poles	6	
Type	A71C-F5	A71C-F6
Frequency (±2%)	50 Hz	60 Hz
Supply Voltage (3phase)	220-240V Δ / 380-420V Y	240-280V Δ / 400-480V Y
Nominal Current	3,5 A / 2,0 A	3,2 A / 1,9 A
Input Power	0,93 kW	0,96 kW
Speed	960 rpm	1152 rpm
Sound Pressure (L_{PA} 1m/2m)	75 dB(A) / 70 dB(A)	80 dB(A) / 75 dB(A)
Air Flow	4,29 m ³ /s	4,19 m ³ /s
Weight (varies by options)	38 kg	

Air flow and sound pressure level (SPL) are given for free blowing operation with inlet&outlet guard grids. SPL values at 1m are measured from side of the fan. SPL values at 2m are calculated by inverse square law. Declared values may change according to the requested options and configuration

► Performance

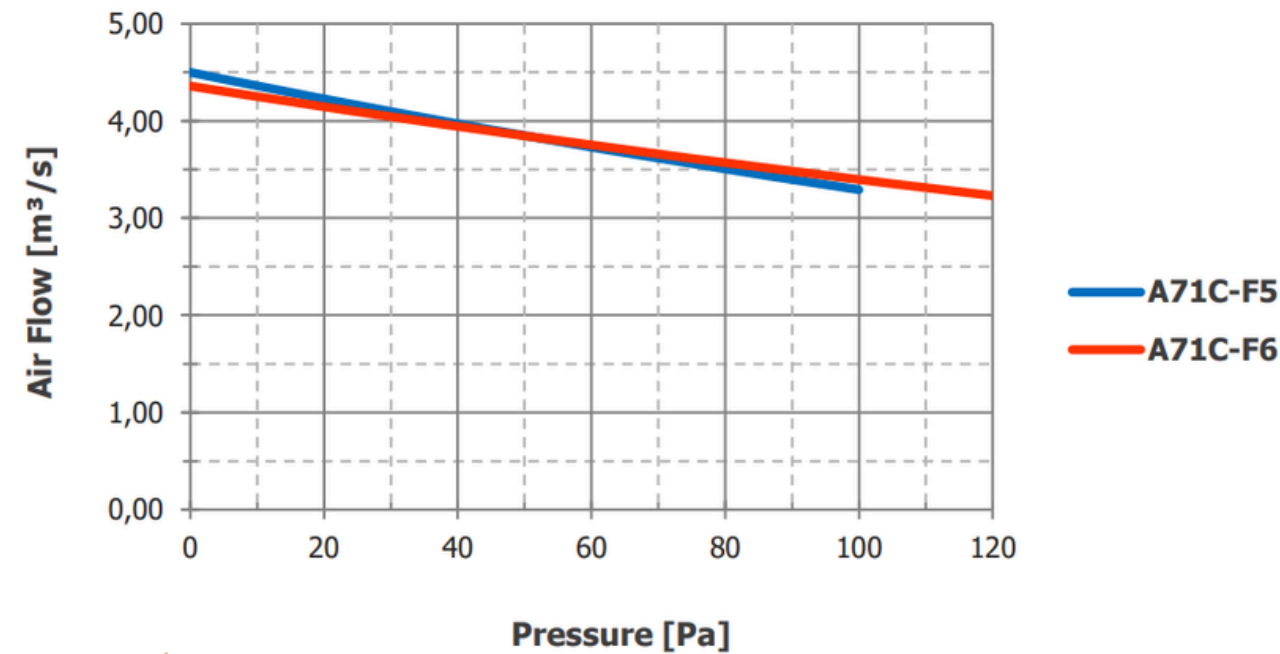

► Dimensions

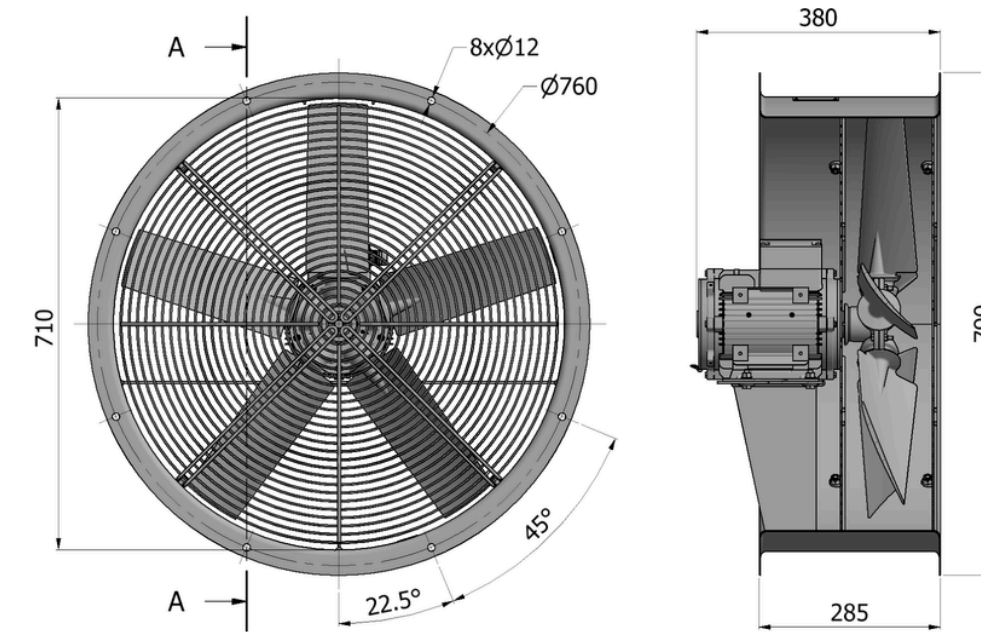

► Configuration

Motor Protection Class	<input type="checkbox"/> IP55	<input type="checkbox"/> IP56	<input type="checkbox"/> IP65	<input type="checkbox"/> IP66
Wings	<input type="checkbox"/> GFR Polyamide		<input type="checkbox"/> Aluminum	
Protection Grids	<input type="checkbox"/> Rear		<input type="checkbox"/> Front	
Color (housing,motor,grids)	<input type="checkbox"/> RAL7031	<input type="checkbox"/> RAL7032	<input type="checkbox"/> RAL7033	<input type="checkbox"/> Other RAL
Operation Ambient (°C)	<input type="checkbox"/> -25~+60	<input type="checkbox"/> -25~+70	<input type="checkbox"/> -40~+60	<input type="checkbox"/> -40~+70
Corrosion Class	<input type="checkbox"/> C3	<input type="checkbox"/> C4	<input type="checkbox"/> C5	Medium/High
Tropical Environment	<input type="checkbox"/> No		<input type="checkbox"/> Yes	
Thermal Protection	<input type="checkbox"/> No		<input type="checkbox"/> Yes	

Thermal protection requires an external control unit or relay to operate. Motor shall be equipped with an embeded space heater for below -25 °C ambient and tropical environment

