

## ► Dimensions

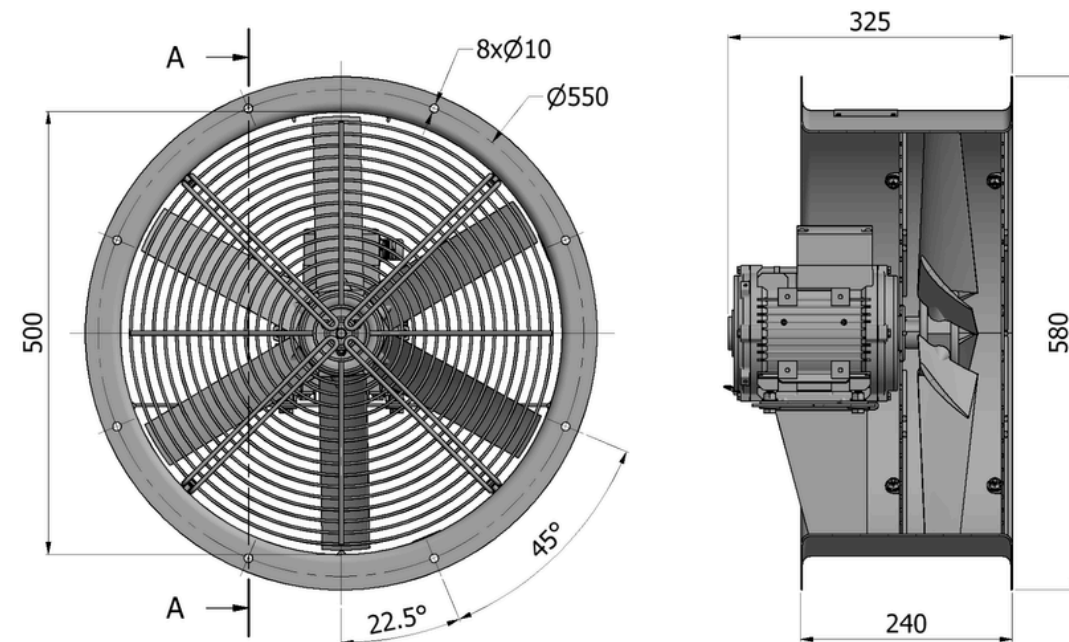

## ► Configuration

<b>Motor Protection Class</b>	<input type="checkbox"/> IP55	<input type="checkbox"/> IP56	<input type="checkbox"/> IP65	<input type="checkbox"/> IP66
<b>Wings</b>	<input type="checkbox"/> GFR Polyamide	<input type="checkbox"/> Aluminum		
<b>Protection Grids</b>	<input type="checkbox"/> Rear	<input type="checkbox"/> Front		
<b>Color (housing, motor, grids)</b>	<input type="checkbox"/> RAL7031	<input type="checkbox"/> RAL7032	<input type="checkbox"/> RAL7033	<input type="checkbox"/> Other RAL
<b>Operation Ambient (°C)</b>	<input type="checkbox"/> -25~+60	<input type="checkbox"/> -25~+70	<input type="checkbox"/> -40~+60	<input type="checkbox"/> -40~+70
<b>Corrosion Class</b>	<input type="checkbox"/> C3	<input type="checkbox"/> C4	<input type="checkbox"/> C5	Medium/High
<b>Tropical Environment</b>	<input type="checkbox"/> No		<input type="checkbox"/> Yes	
<b>Thermal Protection</b>	<input type="checkbox"/> No		<input type="checkbox"/> Yes	

Thermal protection requires an external control unit or relay to operate. Motor shall be equipped with an embeded space heater for below -25 °C ambient and tropical environment

## ► Specification

<b>Number of Poles</b>	4	
<b>Type</b>	A50C-F5	A50C-F6
<b>Frequency (±2%)</b>	50 Hz	60 Hz
<b>Supply Voltage (3phase)</b>	220-240V Δ / 380-420V Y	240-280V Δ / 400-480V Y
<b>Nominal Current</b>	2,5 A / 1,4 A	2,2 A / 1,3 A
<b>Input Power</b>	0,63 kW	0,70 kW
<b>Speed</b>	1440 rpm	1728 rpm
<b>Sound Pressure (L<sub>PA</sub> 1m/2m)</b>	76 dB(A) / 71 dB(A)	81 dB(A) / 76 dB(A)
<b>Air Flow</b>	2,29 m <sup>3</sup> /s	2,42 m <sup>3</sup> /s
<b>Weight (varies by options)</b>	23 kg	

Air flow and sound pressure level (SPL) are given for free blowing operation with inlet&outlet guard grids. SPL values at 1m are measured from side of the fan. SPL values at 2m are calculated by inverse square law. Declared values may change according to the requested options and configuration

## ► Performance

